

Side Connector

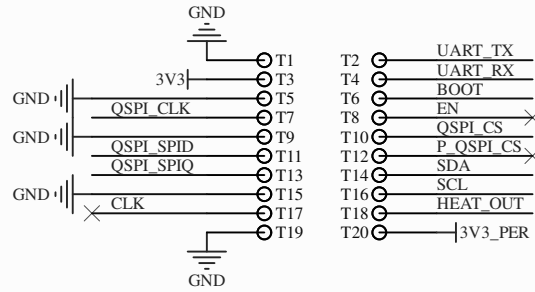

Temperature Control

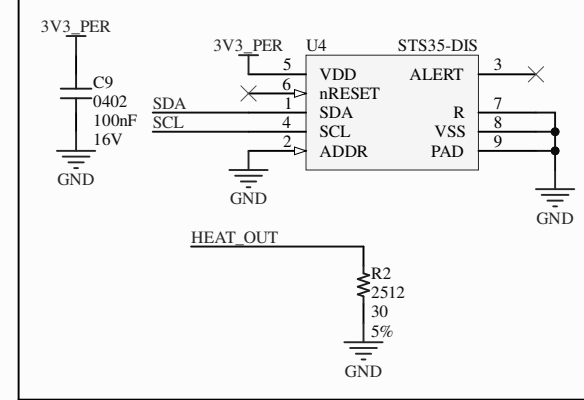

ESP32-C6

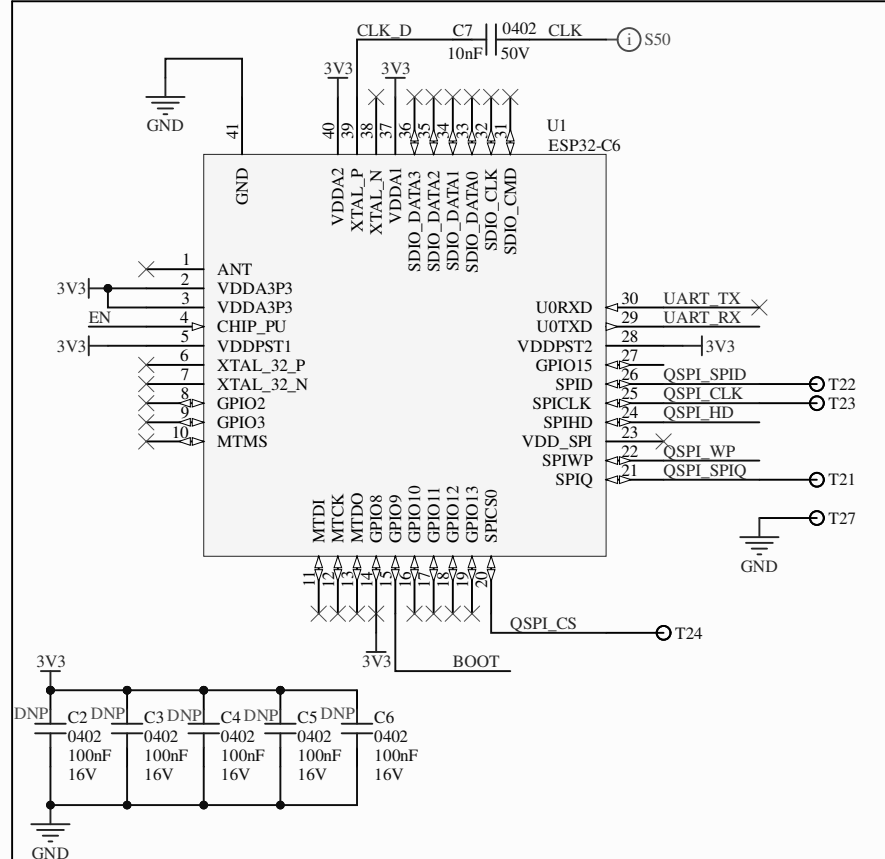

Flash

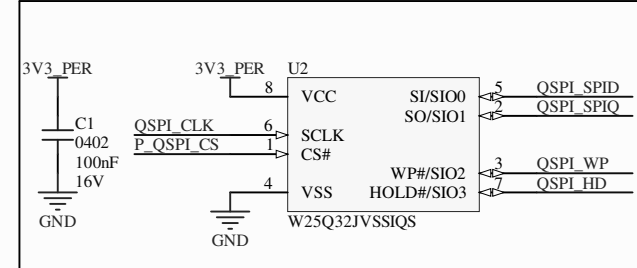

Project: ESP32C6_CPA_Cartridge			
File: CARTRIDGE.SchDoc			
Size: A4	Notes:	Revision: 2.0	
Date: 26/08/2023	Sheet: 1 of 1		
This work is licensed under a Creative Commons Attribution-ShareAlike 4.0 International License.			